

SERVICE BULLETIN

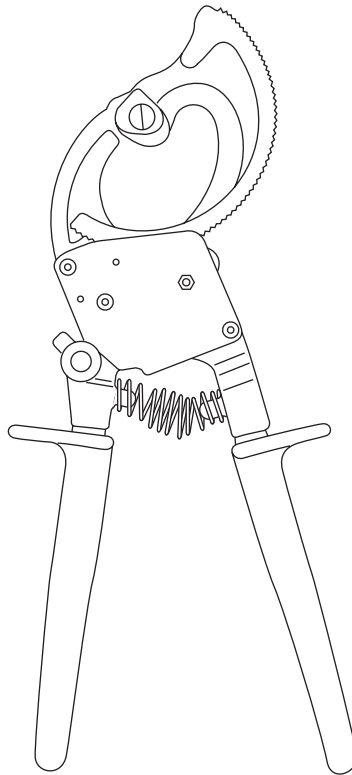

760

Ratchet Cable Cutter





Read and understand all of the instructions and safety information in this manual before operating or servicing this tool.

IMPORTANT SAFETY INFORMATION

	<p>SAFETY ALERT SYMBOL</p>
<p>This symbol is used to call your attention to hazards or unsafe practices which could result in an injury or property damage. The signal word, defined below, indicates the severity of the hazard. The message after the signal word provides information for preventing or avoiding the hazard.</p>	
<p>⚠ DANGER</p>	
<p>Immediate hazards which, if not avoided, WILL result in severe injury or death.</p>	
<p>⚠ WARNING</p>	
<p>Hazards which, if not avoided, COULD result in severe injury or death.</p>	
<p>⚠ CAUTION</p>	
<p>Hazards or unsafe practices which, if not avoided, MAY result in injury or property damage.</p>	

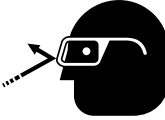
	<p>⚠ WARNING</p>
	<p>Electric shock hazard: This tool is not insulated. Contact with live circuits could result in severe injury or death.</p>

	<p>⚠ WARNING</p>
	<p>Wear eye protection when operating or servicing this tool. Failure to wear eye protection could result in serious eye injury from flying debris.</p>

	<p>⚠ WARNING</p>
	<p>Keep hands and fingers clear of blades. Failure to observe this warning could result in severe injury or death.</p>

Note: Keep all decals clean and legible, and replace when necessary.

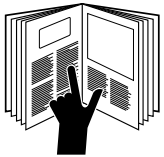
	<p>⚠ WARNING</p>
	<p>Read and understand all of the instructions and safety information in this manual before operating or servicing this tool. Failure to observe this warning could result in severe injury or death.</p>

All specifications are nominal and may change as design improvements occur. Greenlee Textron Inc. shall not be liable for damages resulting from misapplication or misuse of its products.

KEEP THIS MANUAL

Specifications

Length: 11-3/4" (298 mm)

Weight: 1.75 lb (0.8 kg)

Capacity

	Maximum	Frequent Use
Copper	1000 kcmil (MCM) (500 mm ²)	750 kcmil (MCM) (400 mm ²)
Aluminum	1000 kcmil (MCM) (500 mm ²)	1000 kcmil (MCM) (500 mm ²)
Communications Cable	1-3/4" diameter (44 mm ²)	—

IMPORTANT

Do not cut ACSR or steel.

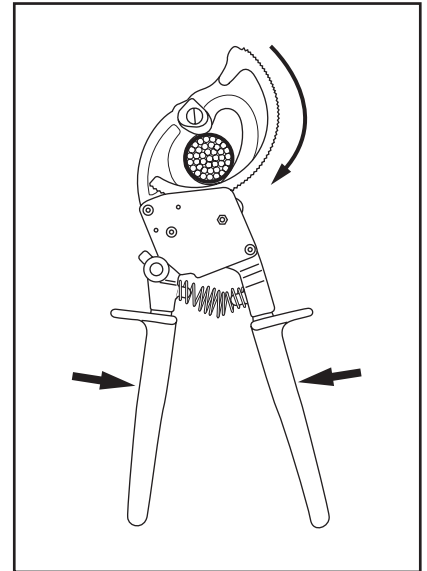
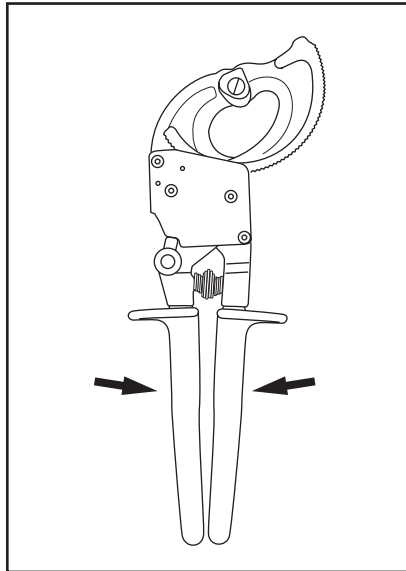
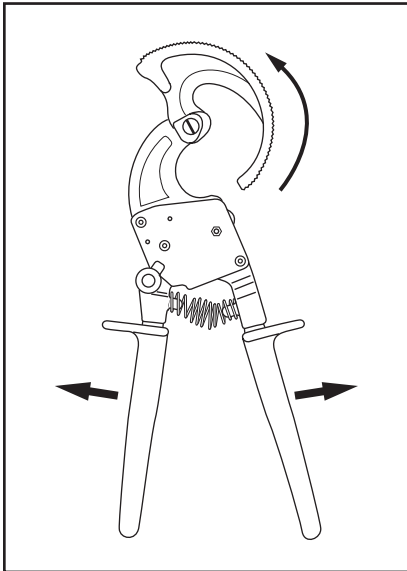
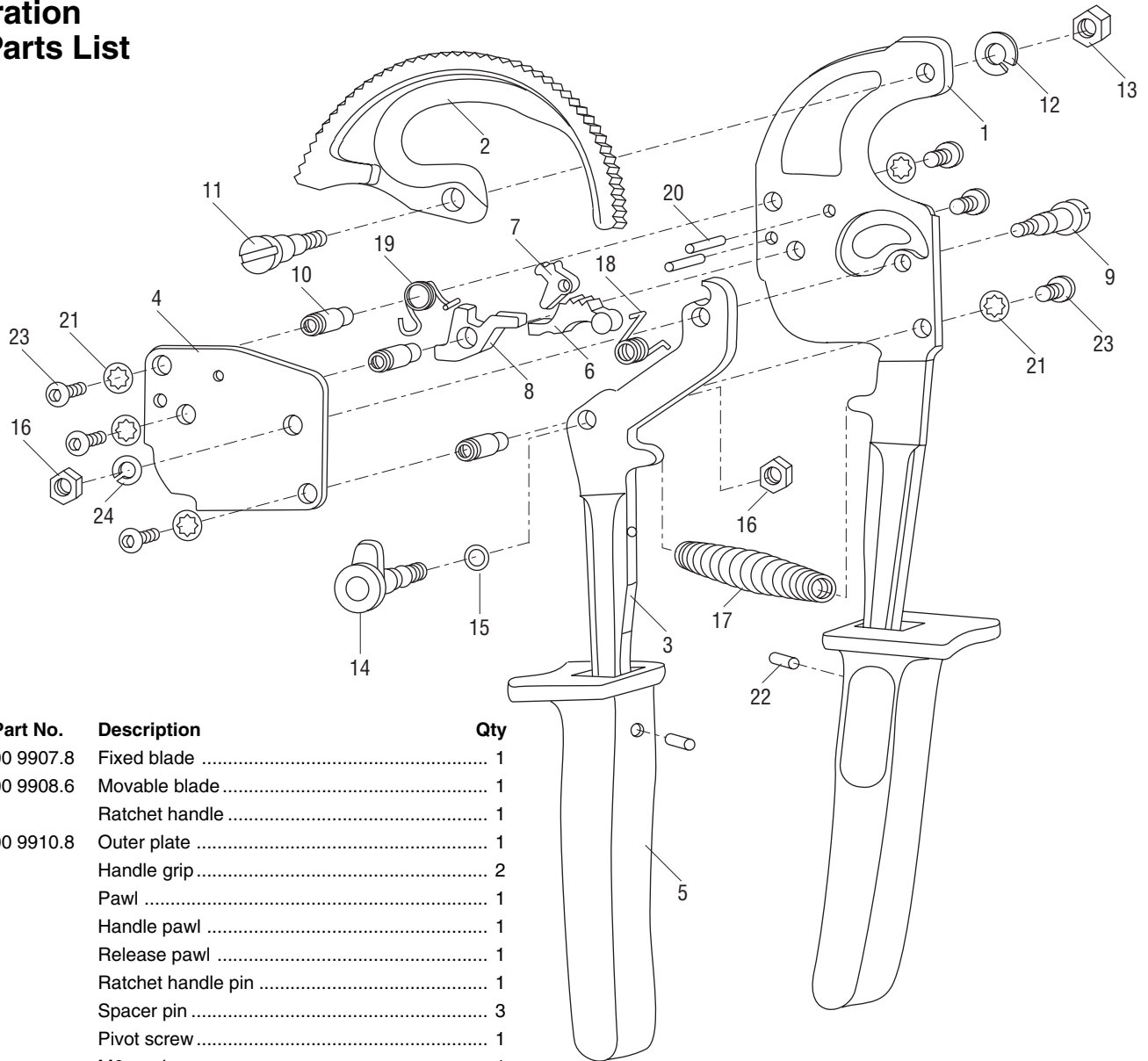

Illustration and Parts List



Key	Part No.	Description	Qty
1	500 9907.8	Fixed blade	1
2	500 9908.6	Movable blade	1
3		Ratchet handle	1
4	500 9910.8	Outer plate	1
5		Handle grip	2
6		Pawl	1
7		Handle pawl	1
8		Release pawl	1
9		Ratchet handle pin	1
10		Spacer pin	3
11		Pivot screw	1
12		M6 washer	1
13		M6 lock nut	1
14		Ratchet lever knob	1
15		O-ring	1
16		M4 lock nut	2
17	500 9922.1	Coil spring	1
18		Pawl spring	1
19		Ratchet pawl spring	1
20		Ratchet pawl set pin	2
21		M4 lock tooth washer	6
22		Handle grip set plug	2
23		Socket head set screw	6
24		M4 spring washer	1

Repair Kits (quantities as listed above)

- 500 1170.7 Pawl kit (includes items 6–8, 18–20)
- 500 1178.2 Pivot screw kit (includes items 9, 11–13, 16, 24)
- 500 1179.0 Set screw kit (includes items 10, 21, 23)
- 500 1182.0 Ratchet lever knob kit (includes items 14–16)
- 500 1185.5 Handle with grip and plug kit (includes items 3, 5, 17, 22)

