

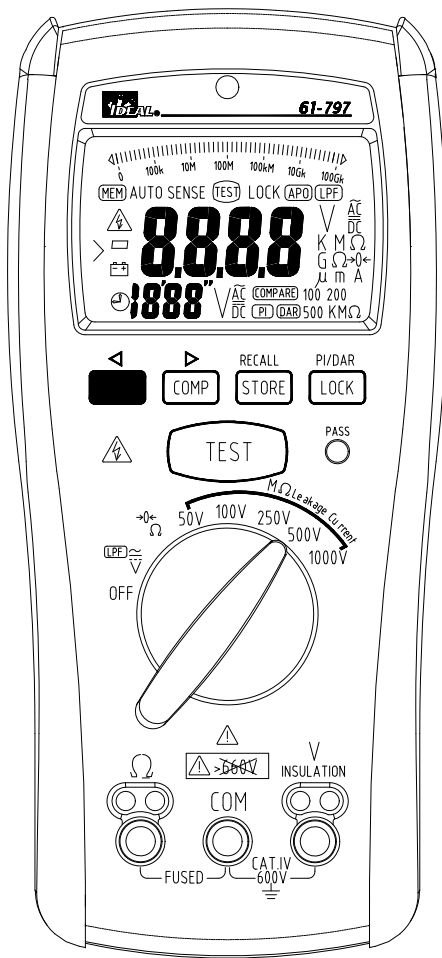

#61-797
Digital Multimeter



CE

TABLE OF CONTENTS

1.Introduction

Precautions and Safety Information

Symbols

Safety

2.Specifications

General Specifications

Electrical Specifications

Required Equipment

3.Basic Maintenance

Battery and Fuse Replacement

4. Performance Tests

5. Calibration Procedure

1. Introduction

Warning

To avoid shock or injury, do not perform the verification tests or calibration procedures described in the manual unless you are qualified to do so.

The information provided in this document is for the use of qualified personnel only.

Caution

The meter contain parts that can be damaged by static discharge.

Follow the standard practices for handling static sensitive devices.

For additional information about APPA TECHNOLOGY CORP. and its products, and services, visit APPA TECHNOLOGY CORP. web site at:

www.appatech.com

Precautions and Safety Information











Use the Meter only as described in the Service Manual. If you do not do so, the protection provided by the Meter may be impaired. Read the “Safety Information” page before servicing this product.

In this manual, a **Warning** identifies conditions and actions that pose hazard (s) to the user; a **Caution** identifies conditions and actions that may damage the Meter or the test instruments.

The Symbols

The symbols used on the Meter and in this manual are explained in Table 1.

Table 1-1. The Symbols

	Risk of electric shock
	See instruction manual
	DC measurement
	Equipment protected by double or reinforced insulation
	Battery
	Fuse
	Earth
	AC measurement
	Conforms to EU directives
	Do not discard this product or throw away.

SAFETY

Review the following safety precautions to avoid injury and prevent damage to this product or products connected to it. To avoid potential hazards, use the product only as specified.

 **CAUTION:** These statements identify conditions or practices that could result in damage to the equipment or other property.

 **WARNING:** These statements identify conditions or practices that could result in personal injury or loss of life.

Specific precautions

Do not operate without covers. To avoid personal injury, do not apply any voltage or current to the product without covers in place.

Electric overload. Never apply a voltage to a connector on the product that is outside the range specified for that connector.

Avoid electric shock. To avoid injury or loss of life, do not connect or disconnect probes or test leads while they are connected to a voltage source.

Do not operate in wet/damp conditions. To avoid electric shock, do not operate this product in wet or damp conditions.

2. Specifications

General Specifications

Maximum voltage applied to any terminal :

600 V ac rms or dc.

Display : 4000 counts.

Polarity Indication :

Automatic, positive implied, negative indicated.

Overrange Indication : OL

Batteries Life :

Resistance Measurements : Tester can perform at least 2600 earth-bond resistance measurements with new alkaline batteries at room temperature. These are standard tests of 1 Ω with a duty cycle of 5 seconds on and 25 seconds off.

Insulation test: Tester can perform at least 1100 insulation tests with new alkaline batteries at room temperature.

These are standard tests of 1 M Ω at 1000 V with a duty cycle of 5 seconds on and 25 seconds off.

Low Batteries Indication : "  " is displayed when the batteries voltage drops below operating voltage.

Low battery voltage : Approx. 4.5V

Auto Power Off : Approx 20 minutes.

Operating Ambient : Non-condensing $\leq 10^{\circ}\text{C}$,

11 $^{\circ}\text{C}$ ~ 30 $^{\circ}\text{C}$ ($\leq 80\%$ RH),

30 $^{\circ}\text{C}$ ~ 40 $^{\circ}\text{C}$ ($\leq 75\%$ RH),

40 $^{\circ}\text{C}$ ~ 50 $^{\circ}\text{C}$ ($\leq 45\%$ RH)

Storage Temperature :

-20 $^{\circ}\text{C}$ to 60 $^{\circ}\text{C}$, 0 to 80% R.H. (batteries not fitted)

Temperature Coefficient :

0.15 x (Spec.Accy)/ $^{\circ}\text{C}$, < 18 $^{\circ}\text{C}$ or > 28 $^{\circ}\text{C}$.

Measure : Samples 2 times per second nominal.

Altitude : 6561.7 ft (2000m)

Safety : Complies with EN61010-1, UL61010-1, IEC 61010-1,

V/ Ω : CAT.IV. 600V.

Compliance to EN 61557 : IEC61557-1, IEC61557-2,

IEC61557-4, IEC61557-10

Weight : (630g) including battery.

Dimensions (W x H x D) :

95mm x207mm x 52mm with holster.

Accessories : Battery (installed), Test leads and user manual.

Power Requirements : 1.5V x 4 IEC LR6 or AA size.

Pollution degree : 2

EMC : EN 61326-1

Shock vibration : Sinusoidal vibration per MIL-T- 28800E
(5 ~ 55 Hz, 3g maximum).

Drop Protection :

4 feet drop to hardwood on concrete floor.

Indoor Use.

Electrical Specifications

Accuracy is \pm (% reading + number of digits) at 23°C \pm 5°C
< 80%RH.

Voltage Measurement

Function	Range	Accuracy
DCV	600.0V	\pm (1%+5dgt)
ACV	600.0V	\pm (1.5%+5dgt)(50~60Hz) \pm (2%+5dgt)(61~500Hz)
LPF ACV	600.0V	\pm (1.5%+5dgt)(50~60Hz) \pm (5%+5dgt)((61~400Hz)

Start measuring voltage : \geq AC 0.6V.

Over voltage protection : 600V rms or ac.

Input Impedance : 3M Ω // less than 100pF.

CMRR / NMRR : (Common Mode Rejection Ratio)

(Normal Mode Rejection Ratio)

VAC : CMRR > 60dB at DC, 50Hz / 60Hz

VDC : CMRR > 100dB at DC, 50Hz / 60Hz

NMRR > 50dB at DC, 50Hz / 60Hz

AC Conversion Type :

AC Conversions are ac-coupled, true rms responding, calibrated to the rms value of a sine wave input.

For non-sine wave add the following Crest Factor corrections:

For Crest Factor of 1.4 to 2.0, add 1.0% to accuracy.

For Crest Factor of 2.0 to 2.5, add 2.5% to accuracy.

For Crest Factor of 2.5 to 3.0, add 4.0% to accuracy.

CF 3 @ 330V

2 @ 500V

Earth-bond resistance Measurement

Function	Range	Accuracy
Earth-bond Resistance	40.00Ω	±(1.5%+5dgt)*
	400.0Ω	±(1.5%+3dgt)
	4000Ω	
	40.00kΩ	

*<1.00Ω add 3dgt

Open Circuit Test Voltage : >4.0V,<8V

Short Circuit Current : >200.0mA

Live Circuit Detection: if ≥2V ac/dc at inputs, test inhibited.

Insulation resistance Measurement

Function	Range	Accuracy
Insulation Resistance	4.000MΩ 40.00MΩ	±(1.5%+5dgt)
	400.0MΩ 4000MΩ	±(3%+5dgt)
	4.1GΩ~20.0GΩ	±(10%+3dgt)

Test Voltage vs. Maximum resistance range :

50V/50.0MΩ,100V/100.0MΩ,250V/250.0MΩ,500V/500MΩ
and 1000V/20.0GΩ.

Test Voltage vs. Minimum resistance (with test current=1mA) :

50V/50kΩ,100V/100kΩ,250V/250kΩ,500V/500kΩ and
1000V/1MΩ.

Test Voltage Accuracy : -0%,+20%

Short Circuit Test Current:1mA(nominal)

Auto discharge function : discharge time<1 sec for C ≤ 1μF

Maximum Capacitive load : Operable with up to 1μF load

Live Circuit Detection : if ≥30V ac/dc at inputs, test inhibited

Required Equipment

Required equipment is listed in Table B. If the recommended models are not available, equipment with equivalent specifications may be used.

Repairs or servicing should be performed only by qualified personnel.

Table 2-1

Equipment	Required Characteristics	Recommended Model
Calibrator	AC Voltage Range: 0 - 600 V Frequency Range: 50 Hz - 500 Hz Accuracy: +/- 0.1%(Basic) DC Voltage: 0 - 600 V Accuracy: +/-0.1%(Basic) DC Current: 0-400mA Accuracy: +/-0.1%(Basic)	Fluke 5700 or Wavetek 9100 Calibrator
DMM	DC Voltage: 0 - 1000 V Accuracy: +/-0.5%(Basic) DC Current: 0-400mA Accuracy: +/-0.5%(Basic)	
High voltage Divider	DC Voltage Range: 1 kV -5 kV Accuracy: 1% Division Ratio: 1000:1 Input resistance : 1000 M Ω	Fluke 80k-6
High voltage Resistor (>1kV)	Suggest the insulation tester to use physical high voltage resistors at \pm 5% tolerance as listed : 50k Ω , 100k Ω , 250k Ω , 500k Ω , 1M Ω , 40M Ω , 400M Ω , 4G Ω , 18G Ω	To verify the actual resistance value by Fluke 8508. Then, use the actual value to calibrate the insulation meter.
Resistor	Suggest the insulation tester to use physical high voltage resistors at \pm 1% tolerance as listed : 2 Ω (0.5W),36 Ω ,360 Ω ,3.6k Ω ,36k Ω	Same as above

3. Basic Maintenance

⚠ Warning

To avoid shock, remove the test leads and any input signals before opening the case or replacing the battery.

Battery and Fuse Replacement

Refer to the following figure to replace fuse and the batteries:

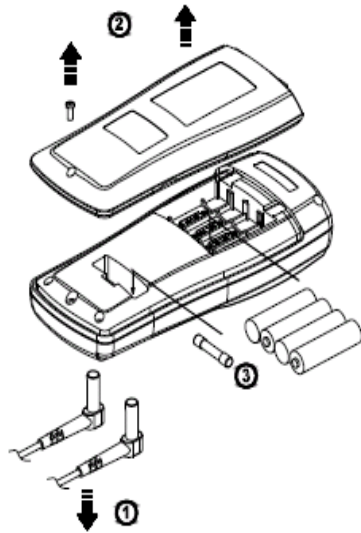

⚠ Caution

- Use only a fuse with the amperage, interrupt, voltage, and speed rating specified.
- Fuse rating : Fast, 315mA, 1000V, Min Interrupt Rating 10000A
- Replace the batteries as soon as the low batteries indicator "⚡" appears, to avoid false reading.
- When the battery is too low for reliable operation, the meter displays "bAtt". The meter will not operate at all until the battery is replaced.
- 1.5V x 4 alkaline batteries.

4. Performance Tests

The following performance tests verify the complete operability of the Meter and check the accuracy of each Meter function against the Meter's specifications. Accuracy specifications are valid for a period of one year after calibration, when measured at an operating temperature of 18°C to 28°C and a maximum of 80% relative humidity.

To perform the following tests, it is not necessary to open the case, no Adjustments are necessary, merely make the required connections, apply the designated inputs, determine if the reading on the Meter display falls within the acceptable range indicated.

Table 4-1 Testing the Voltage Function

function	Calibrator Output	Reading	
		Low limit	High limit
DCV	2	1.5V	2.5V
	-2	-2.5V	-1.5V
	60	-58.9V	61.1V
	-60	-61.1V	-58.9V
	300	296.5V	303.5V
	-300	-303.5V	-296.5V
	600	593.5V	606.5V
	-600	-606.5V	-593.5V
ACV	2V ,50Hz	1.5V	2.5V
	54V ,50Hz	52.7V	55.3V
	66V ,50Hz	64.5V	67.5V
	300V,50Hz	295.0V	305.0V
	600V,50Hz	590.5V	609.5V
	2V ,500Hz	1.5V	2.5V
	54V ,500Hz	52.4V	55.6V
	66V ,500Hz	64.2V	67.8V
	300V,500Hz	293.5V	306.5V
	600V,500Hz	587.5V	612.5V

function	Calibrator Output	Reading	
		Low limit	High limit
LPF ACV	2V ,50Hz	1.5V	2.5V
	54V ,50Hz	52.7V	55.3V
	66V ,50Hz	64.5V	67.5V
	300V,50Hz	295.0V	305.0V
	600V,50Hz	590.5V	609.5V
	2V ,400Hz	1.4V	2.6V
	54V ,400Hz	50.8V	57.2V
	66V ,400Hz	62.2V	69.8V
	300V,400Hz	284.5V	315.5V
	600V,400Hz	569.5V	630.5V

Table 4-2 Testing the Earth-bond Function

function	Applied	Reading	
		Low limit	High limit
Ω	2.00 Ω	1.92 Ω	2.08 Ω
	36.00 Ω	35.41 Ω	36.59 Ω
	360.0 Ω	354.3 Ω	365.7 Ω
	3600 Ω	3543 Ω	3657 Ω
	36.00k Ω	35.43k Ω	36.57k Ω

Table 4-3 Testing the Insulation Function

function	Applied	Reading	
		Low limit	High limit
1000V	18G Ω	15.9G Ω	20.1G Ω
	4G Ω	3875M Ω	4125M Ω
	400M Ω	387.5 M Ω	412.5 M Ω
	40M Ω	39.35 M Ω	40.65 M Ω
	4M Ω	3.935 M Ω	4.065 M Ω
	1M Ω	0.980 M Ω	1.020 M Ω
500V	500k Ω	0.488 M Ω	0.512 M Ω
250V	250k Ω	0.241M Ω	0.259 M Ω
100V	100k Ω	0.993 M Ω	0.107 M Ω
50V	50k Ω	0.045M Ω	0.055 M Ω

5. Calibration Procedure

Enter Calibration mode : Press and hold the TEST button, and simultaneously turn the UUT on, wait until the display shows “8888”. Release the TEST button, and press the button as following sequence to enter the calibration mode:

BLUE=>COMP=>STORE=>LOCK=>STORE=>COMP=>STORE=>LOCK

STORE button: Press once to save the calibration value, and “SAVE” will be displayed.

COMP button : Press once to enter the next step.

Table 5-1 Calibration steps for insulation function

Switch position: 50V insulation		
Input Terminal: +: COM / -: gnd(remote probe pin)		
Adjustment Step	Standard value	Press button
01L	1.600mA, 0Hz	Waiting for reading stable, press STORE button.
01-		Check the reading, and press COMP button
02L	540.0uA, 0Hz	Same as above.
02-		
03L	160.0uA, 0Hz	Same as above.
03-		
04L	54.00 uA, 0Hz	Same as above.
04-		
05L	16.00uA, 0Hz	Waiting for reading stable, press STORE button
05-		Check the reading

Table 5-2 Calibration steps for Ω (Earth-bond) function

Switch position: Ω / ->0<-		
Input Terminal: +: COM / -:gnd(remote probe pin)		
Adjustment Step	Standard value	Press button
06L	360.0mA, 0Hz	Waiting for reading stable, press STORE button
06-		Check the reading, and press COMP button
07L	36.00mA, 0Hz	Same as above.
07-		
08L	3.600mA, 0Hz	Same as above.
08-		
09L	360.0uA, 0Hz	Waiting for reading stable, press STORE button
09-		Check the reading

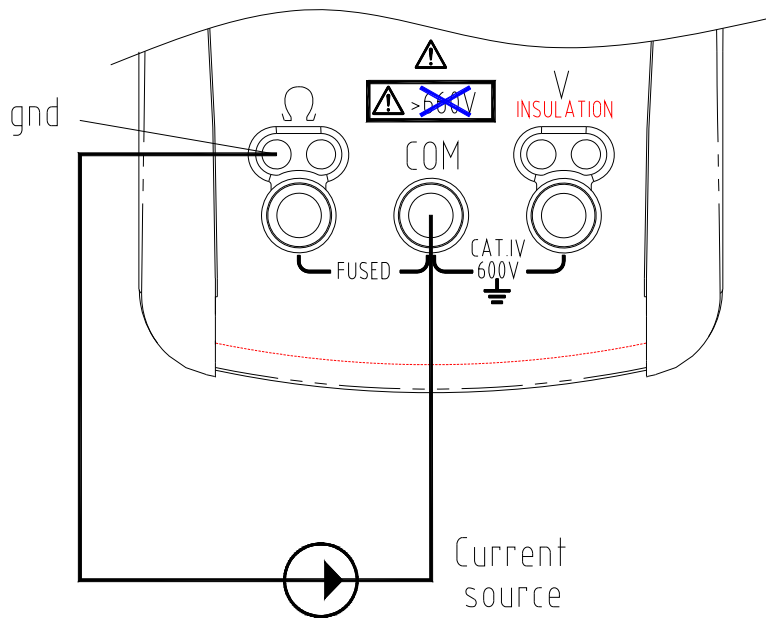

Table 5-3 Calibration steps for Ω (Earth-bond) function

Switch position: Ω / ->0<-		
Input Terminal: +: Ω input/ -:COM		
Adjustment Step	Standard value	Press button
10L	0.560V, 0Hz	Waiting for reading stable, press STORE button
10H	3.600V, 0Hz	Same as above.
10-		Check the reading, and press COMP button
11L	1.800V, 50Hz	Waiting for reading stable, press STORE button
11-		Check the reading, and press COMP button
12L	0.00 Ω (Short the inputs)	Waiting for reading stable, press STORE button
12-		Check the reading.

Table 5-4 Calibration steps for Voltage function

Switch position : V		
Input Terminal : +:V input/ -:COM		
Adjustment Step	Standard value	Press button
13L	10.0V	Waiting for reading stable, press STORE button
13H	100.00V	Waiting for reading stable, press STORE button
13-		Check the reading, and press COMP button
14L	30.0V	Same as above
14H	750.0V	
14-		
15L	5.6V, 50Hz	Same as above
15H	56.0V, 50Hz	
15-		
16L	56.0V, 50Hz	Same as above
16H	560.0V, 50Hz	
16-		
17L (LPF)	5.6V, 50Hz	Same as above
17H	56.0V, 50Hz	
17-		
18L (LPF)	56.0V, 50Hz	Waiting for reading stable, press STORE button
18H	560.0V, 50Hz	Waiting for reading stable, press STORE button
18-		Check the reading.

Table 5-5 Calibration steps for Battery voltage

Switch position : 100V insulation		
Input Terminal : +: Battery + Terminal / -: Battery – Terminal		
Adjustment Step	Standard value *	Press button
19L	5.00V	Waiting for reading stable, press STORE button
19-		Check the reading.

* Remove batteries from UUT battery compartment. Connect a + 5.00 V lab supply to the + and - battery terminals.

Table 5-6

Switch position : 1000V insulation		
output Terminal : +:V input/ -:COM(disconnect the test leads)		
Adjustment Step	Standard value	Press button
20L	55V±3V	Press the TEST button to output and display the test voltage. Press the BLUE/COMP button to lower or raise the test voltage. Then press STORE button to save the calibration value. (The test voltage will be automatically turned off when STORE button is pressed)
20-		Press TEST button to output and display the Test voltage. Check the reading, and press COMP button
21L	110V±3V	Same as above.
21-		
22L	275V±5V	Same as above.
22-		
23L	525V±5V	Same as above.
23-		
24L	1050V±5V	Same as above.
24-		

- If the measured value is greater than 130% of Standard value or lower than 70% of Standard value , "Er" symbol will be displayed, and the STORE button is not available.