

THIS COPY IS PROVIDED ON A RESTRICTED BASIS AND IS NOT TO BE USED IN ANY WAY DETRIMENTAL TO THE INTERESTS OF PANDUIT CORP.

PART#	DESCRIPTION	WEIGHT*
CJSK5E88TG**	8 POSITION, 8 WIRE SHIELDED MODULE WITH INTEGRAL SHIELD. TERMINATION CAP IS COLOR CODED FOR T568A AND T568B WIRING SCHEMES.	3.314 LB/100 PCS (1503g/100 PCS)

\*WEIGHT IS APPROXIMATE  
\*\* = JACK COLOR/KEY SUFFIX (SEE SHEET 2)

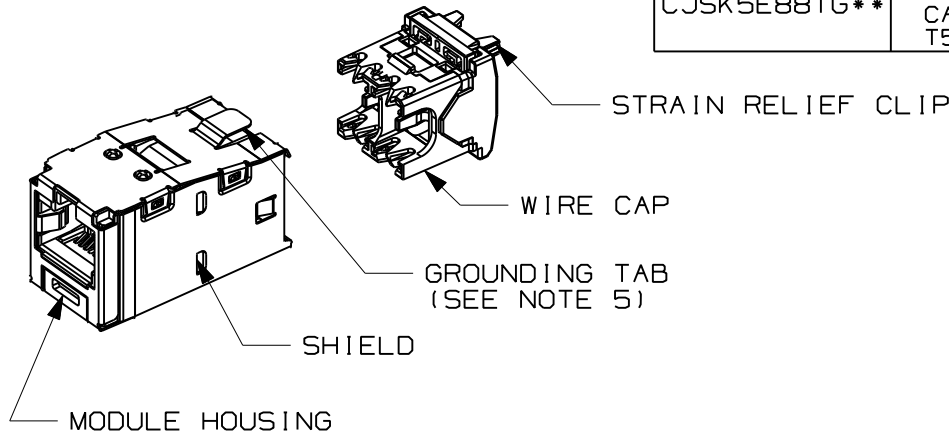

NOTES:

1. RED WIRE CAP DESIGNATES CATEGORY 5e PERFORMANCE.
2. MATERIAL:  
MODULE HOUSING-ABS  
NOMINAL WALL THICKNESS .078(2.0).  
WIRE CAP-PC/ZINC
3. ALL MINI-COM TX5E 8 POSITION, 8 WIRE, KEYED JACK MODULES ARE NOT UNIVERSAL IN DESIGN. EACH MODULE ACCEPTS ONLY ONE SPECIFIC KEYED PLUG THAT MATCHES THE JACK KEYED CONFIGURATION.
4. DIMENSIONS IN PARENTHESES ARE IN METRIC.
5. .187 x .010" GROUNDING TAB PROVIDED AS OPTIONAL CONDUCTIVE PATH FOR GROUNDING.

KEYED FEATURE (SEE SHEET 2)

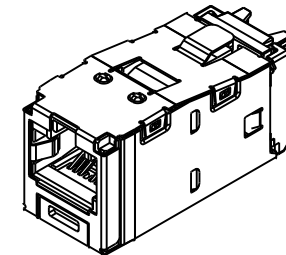
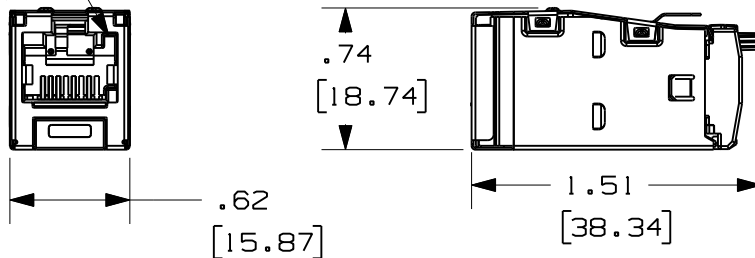

ACTUAL SIZE

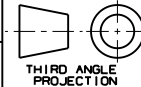
MODEL FILENAME M03011AA/01		SIZE A
DRAWING FILENAME M03011EJ_DC59/00B		
TITLE MINI-COM TX5e SHIELDED KEYED JACK MODULE CUSTOMER DRAWING		
 <b>PANDUIT</b> ™ CORP. TINLEY PARK, ILL 60477		I.T. NUMBER
 THIRD ANGLE PROJECTION		PRODUCT SPEC
ALL DIMENSIONS ARE GIVEN IN INCHES, UNLESS OTHERWISE SPECIFIED. DIMENSIONAL TOLERANCES ARE: (.X) ± (.XXX) ±.010(.3) (.XX) ±.03(.8) ANGLES ±		WORK INSTRUCTION
DRAWN BY MDJr		SCALE FULL
DATE 10-22-08		PART NO. CJSK5E88TG**
CHK'D BMBA		DRAWING NO. 03011-59 SHEET 1 OF 2

REV	DATE	BY	CHK	DESCRIPTION	ECN	R	CUST	SUP	OTH
I	1-27-09	MDJr	PBD	A. UPDATED JACK MODELS ON SHEET 2.	03011-59			VMB	
R	12-03-08	MDJr	BMBA	RELEASED TO PRODUCTION	03011-59			VMB	

**△ SHIELDED JACK COLOR/KEY CODE AND PART NUMBER**

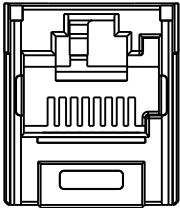
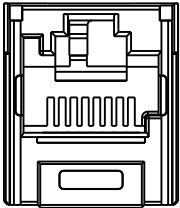
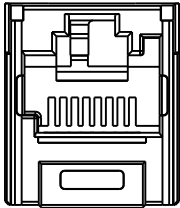
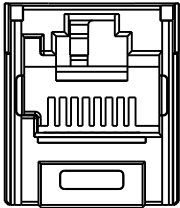
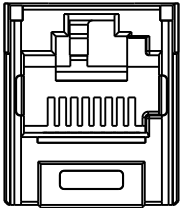
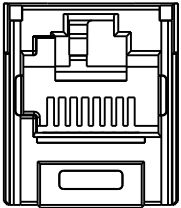
<p>A - BLACK</p>  <p>CJSK5E88TGBL</p>	<p>B - RED</p>  <p>CJSK5E88TGRD</p>	<p>C - GREEN</p>  <p>CJSK5E88TGGR</p>	<p>D - YELLOW</p>  <p>CJSK5E88TGYL</p>	<p>E - ORANGE</p>  <p>CJSK5E88TGOR</p>	<p>F - BLUE</p>  <p>CJSK5E88TGBU</p>
--	--	---	---	---	---

REV	DATE	BY	CHK	DESCRIPTION	ECN	R	CUST	SUP	OTH
I	1-27-09	MDJr	PBD	SEE SHEET ONE FOR CHANGES	03011-59		VMB		
R	12-03-08	MDJr	BMBA	SEE SHEET ONE FOR CHANGES	03011-59		VMB		

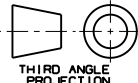
MODEL FILENAME M03011AA/01		SIZE <b>A</b>
DRAWING FILENAME M03011EJ_DC59/00B		
TITLE MINI-COM TX5e SHIELDED KEYED JACK MODULE CUSTOMER DRAWING		
 <b>PANDUIT</b> ™ CORP. TINLEY PARK, ILL 60477	I.I. NUMBER	PRODUCT SPEC
	ALL DIMENSIONS ARE GIVEN IN INCHES, UNLESS OTHERWISE SPECIFIED. DIMENSIONAL TOLERANCES ARE: (.X) ± (.XXX) ± .010(.3) (.XX) ± .03(.8) ANGLES ±	WORK INSTRUCTION
THIRD ANGLE PROJECTION 	DRAWN BY MDJr	REVIEW DRAWING NUMBERS
DATE 10-22-08	PART NO. CJSK5E88TG**	
CHK'D BMBA	DRAWING NO. 03011-59 SHEET 2 OF 2	