

GENERAL - READ COMPLETELY BEFORE INSTALLING

This product allows for several optional installation methods. Available methods for walls are shown here. The raceway (device) consists of an enclosed heavy gauge galvanized steel channel with a detachable lid. Wall plates are designed to accommodate single device installations. Wall plates and gaskets are included.

NOTE: WALL INSTALLATIONS REQUIRE THIS DEVICE TO BE INSTALLED WITH THE TOP (LID) FACING UPWARD. The lid may be identified by the BARRIER GAUGE stamping.

TABLE A: Parts List

| Qty. | Description |
|------|---------------------------|
| 1 | EZ Path™ Mini Device |
| 2 | Wall Plates |
| 2 | Intumescent Gaskets |
| 2 | Ground Screws |
| 1 | 5/64 Allen Key |
| 10 | 8-2 x 1/4" Lg. Set Screws |

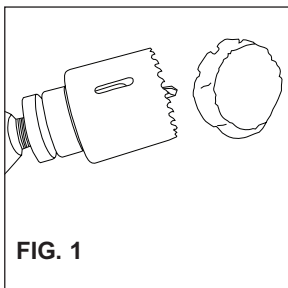

FIG. 1

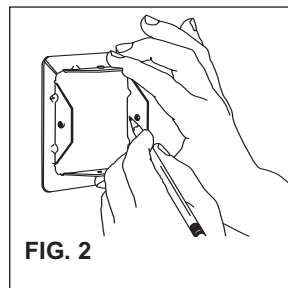

FIG. 2

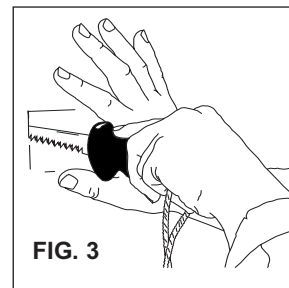

FIG. 3

CREATING THE OPENING

Gypsum Board Walls:

1. Locate suitable area of the wall to penetrate making sure that there are no studs, wires, pipes or other obstructions located within wall.
2. a. Round Openings:
 - i.) Using a 2" hole saw, make an opening on each side of the wall ensuring that the holes are aligned (See Fig. 1).
- b. Square Openings (Optional):
 - i.) Mark a nom 1-3/4" square opening. Make sure opening is square and plumb. The inside opening of the wall plates can be used as a template (See Fig. 2).
 - ii.) Using a keyhole saw, cut wall board (See Fig. 3). Cutting to the outside of the line will produce a slightly over-sized opening. Mark and cut opposite side of the wall, exercising care to align both openings.
3. Insert raceway and check for fit. Remove raceway.
4. Install device per instructions below.

Concrete or Masonry Walls:

1. Core drill a nom 2" round opening in wall or cut or form a nom 1-3/4" square opening.

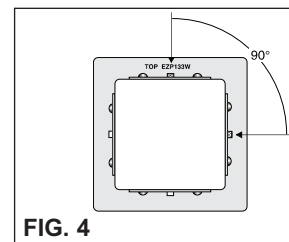

FIG. 4

INSTALLING WIREWAY USING WALL PLATES

Prior to Pulling Cables

Device is installed through wall and attached using wall plates to sandwich the wall. No mechanical attachment to wall itself is required.

1. Pre-install required set screws in wall plates using Allen wrench (provided). NOTE: Two set screws positioned and tightened at 90 degrees to each other in both plates will adequately hold device (See Fig. 4).
2. Install a wall plate around raceway making sure that set screw flanges are facing towards the end of the device. Use gauge marks located on lid of raceway to adjust plate to thickness of wall (See Fig 5). This will center raceway within the wall. When properly adjusted, tighten set screws to lock plate onto raceway.
3. Place one of two provided gaskets around opposite end of raceway and carefully slide it back to fit snugly against back side (wall side) of plate.
4. Insert raceway through wall (with lid gauge marks facing upwards) using previously installed wall plate and gasket as a stop (See Fig. 6).
5. Moving to the opposite side of the wall, install remaining gasket around raceway and slide toward wall.
6. Install remaining wall plate around raceway and slide it toward wall surface. While pulling raceway toward you, push wall plate and gasket tightly to wall and tighten set screws. Check device for excessive play. If device appears to be loose or can easily be moved, readjust wall plates as necessary to tighten device firmly against wall.

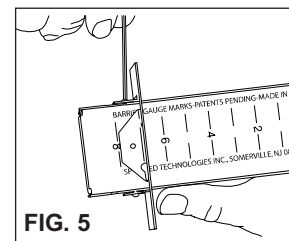

FIG. 5

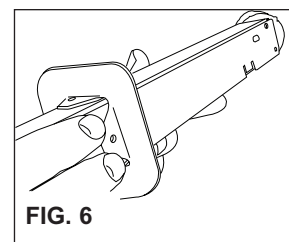

FIG. 6

INSTALLING IN WALL OPENINGS USING SEALANT (NO WALL PLATES)

Installing Around Previously Installed Cables

1. Remove Lid: Lid is secured within the top of the U channel via an extruded boss that snaps into round holes located at both ends on one side of the lid. A slot is provided between the cover and top of the channel next to each boss. Insert a flat-bladed screw driver into the slots and carefully pry the channel open enough to release each boss. Exercise care not to bend or distort the channel. Remove the cover by sliding it out of the slots located on the opposite side of the lid.
2. Place raceway channel around cables (See Fig 7).
3. Replace lid by sliding lid into channel attachment tabs and applying pressure on opposite end until the lid locks back into place.
4. Caulk using approved sealant (SpecSeal® SSS or LCI Series sealants, or Pensil® 300 Silicone Sealant). Apply sealant to a depth of 5/8" within annulus on both sides of wall. Apply a 3/8" crown bead at areas of point contact. In concrete walls, device may be cast or grouted using hydraulic cement or SpecSeal® mortar.

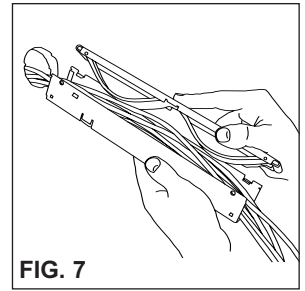

FIG. 7

INSTALLING or PULLING CABLES

A resilient liner provides an adjustable seal within the raceway. Liner must be protected from damage while adding or removing cables. Wrap cable ends with a suitable low friction tape before inserting into the raceway. This device is designed to be fully functional at all cable loadings from completely empty to visually filled and cables should easily slide through the raceway using minimal effort. IF RESISTANCE IS ENCOUNTERED, DO NOT FORCE CABLES OR CABLE BUNDLES THROUGH THE RACEWAY. DAMAGE MAY RESULT. Upper curved liner may be depressed if necessary when inserting cables using a flat, smooth implement and removing after cables are installed.

GROUNDING

At the option of the installer, this device may be grounded. After device and wall plates have been installed, insert ground screws where indicated on wall plate (See Fig. 8). NOTE: Wall plates must be used if grounding is desired.

WALL LABELING

Wall labels are provided with the wireway. Larger orange colored label is intended to be used to identify the wireway's installer as well as to provide applicable UL System information. Two labels are provided for marking both sides of wall.

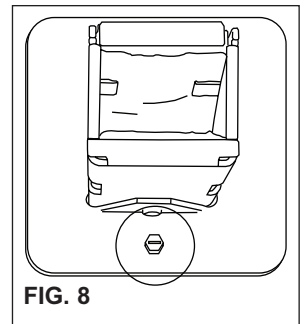

FIG. 8

MAINTENANCE

No maintenance of the raceway is normally required. Interior of device should be inspected before and after any modifications to cable bundle. If any damage to intumescent pads lining top and bottom of the raceway is found, contact the factory to determine if replacement is required.

Important Notice: All statements, technical information, and recommendations contained herein are based upon testing believed to be reliable, but the accuracy and completeness thereof is not guaranteed.

WARRANTY: Specified Technologies Inc. manufactures its goods in a manner to be free of defects. Should any defect occur in its goods (within one year), Specified Technologies Inc., upon prompt notification, will at its option, exchange or repair the goods or refund the purchase price.

Limitations and Exclusions: THIS WARRANTY IS IN LIEU OF ALL OTHER REPRESENTATIONS EXPRESSED OR IMPLIED (INCLUDING THE IMPLIED WARRANTIES OF MERCHANTABILITY OR FITNESS FOR USE) AND UNDER NO CIRCUMSTANCES SHALL SPECIFIED TECHNOLOGIES INC. BE RESPONSIBLE FOR ANY INCIDENTAL OR CONSEQUENTIAL PROPERTY DAMAGE OR LOSSES. PRIOR TO USE, THE USER SHALL DETERMINE THE SUITABILITY OF THE PRODUCT FOR ITS INTENDED USE, AND THE USER ASSUMES ALL RISKS AND LIABILITY FOR SUBSEQUENT USE. No statement or recommendation not contained herein shall have any force or effect unless in an agreement signed by officers of seller and manufacturer.

MADE IN THE USA – COPYRIGHT © 2004 SPECIFIED TECHNOLOGIES, INC.

CITY OF NEW YORK MEA 369-02-M



Specified
Technologies
Inc.