

## 25DTC/AMTC & 25DTP/AMDTP SERIES, E73769, E73770, E73771 TELE-POWER® POLES INSTALLATION INSTRUCTIONS

Wiremold Electrical Systems conform to and should be properly grounded in compliance with requirements of the current National Code or codes administered by local authorities.

All electrical products may represent a possible shock or fire hazard if improperly installed or used. Wiremold electrical products are UL Listed, made for interior use in dry locations only and should be installed in conformance with current local and/or the National Electrical Code.

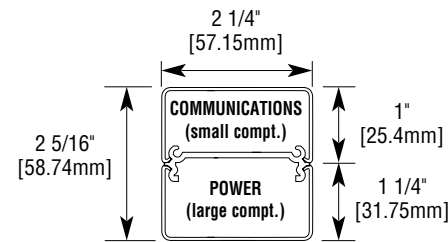

25DTC-4\* / 25DTP-4 / 25DTP-4ACT  
AMTC-4\* / AMDTP-4

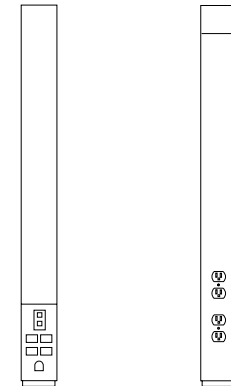

25DTC-4\*  
AMTC-4\*

25DTP-4  
AMDTP-4

RACEWAY WIRE AND CABLE FILL CAPACITIES FOR TELE-POWER POLES - POWER									
Cable Type	Cable Wire/Size Description	O.D.		AMDTP Series		25DTP Series		AMTC & 25DTC Series*	
		(inches)	(mm)	40% FILL	40% FILL	40% FILL	40% FILL	Small Compt.	Large Compt.
THHN / THWN	10 Awg	0.16	4.17	10	10	10	10	34	44
	12 Awg	0.13	3.30	15	15	15	15	54	69

RACEWAY WIRE AND CABLE FILL CAPACITIES FOR TELE-POWER POLES - COMMUNICATIONS											
Cable Type	Cable Wire/Size Description	O.D.		AMDTP Series		25DTP Series		AMTC & 25DTC Series*			
		(inches)	(mm)	20% FILL	40% FILL	20% FILL	40% FILL	20% FILL	40% FILL	20% FILL	40% FILL
Unshielded Twisted Pair	Cat. 5 UTP	0.22	5.59	10	19	10	19	10	19	13	26
	Cat. 3 UTP	0.19	4.83	13	25	13	25	13	25	17	35
Telephone	2 Pair	0.14	3.56	23	47	23	47	23	47	32	64
	3 Pair	0.15	3.81	20	41	20	41	20	41	28	56
	4 Pair	0.19	4.83	13	25	13	25	13	25	17	35
	25 Pair	0.41	10.41	3	5	3	5	3	5	4	7
Coaxial	RG58/U	0.20	4.95	12	24	12	24	12	24	17	33
	RG59/U	0.24	6.15	8	16	8	16	8	16	11	21
	RG62/U	0.24	6.15	8	16	8	16	8	16	11	21
	RG6/U	0.27	6.86	6	13	6	13	6	13	9	17
TwinAxial	100 Ohm	0.33	8.38	4	8	4	8	4	8	6	12
Shielded Twisted Pair	Type 1 STP	0.39	9.91	3	6	3	6	3	6	4	8
	Type 2 STP	0.47	11.81	2	4	2	4	2	4	3	6
	Type 3 STP	0.25	6.22	8	15	8	15	8	15	10	21
Fiber Optic	Fiber ZipCord	0.11	2.79	38	76	38	76	38	76	52	104
	Round Fiber 2 Strand	0.18	4.57	14	28	14	28	14	28	19	39
	Round Fiber 4 Strand	0.19	4.83	13	25	13	25	13	25	17	35
	Round Fiber 6 Strand	0.21	5.33	10	21	10	21	10	21	14	29

\* 25DTC/AMTC Series not intended for combining power and communications.

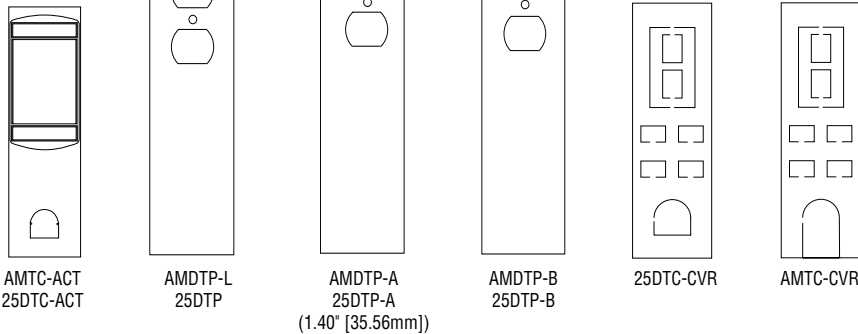

**The Wiremold Company**  
60 Woodlawn Street  
West Hartford, CT 06110  
Tel. (860) 233-6251 Fax 860-232-2062

1

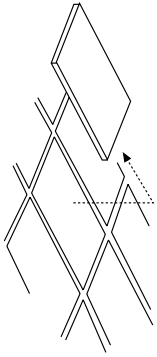

2a

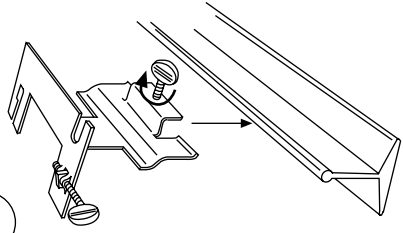

2b

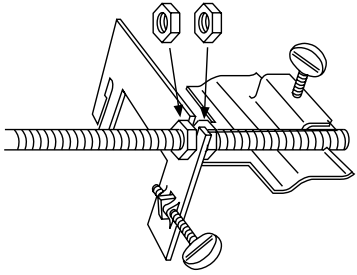

3

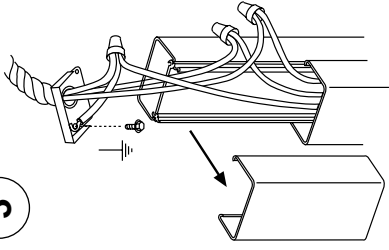

4

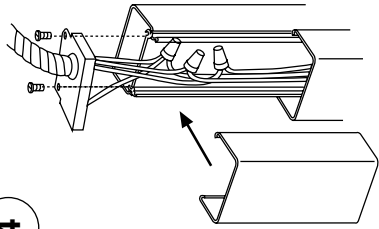

5

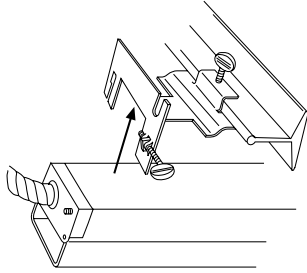

6a

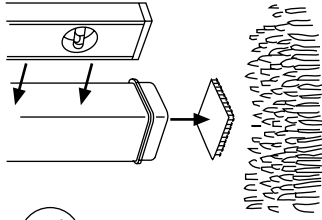

6b

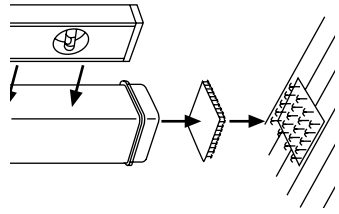

7

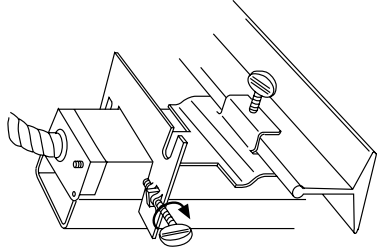

8

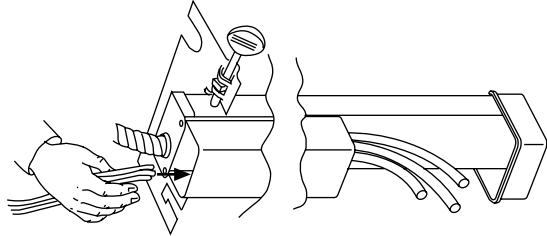

9a

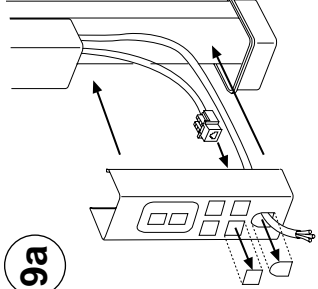

9b

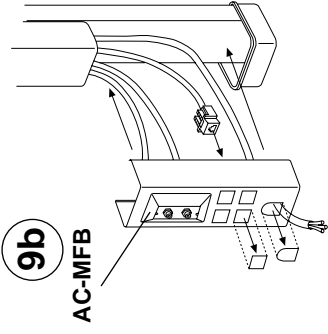

9c

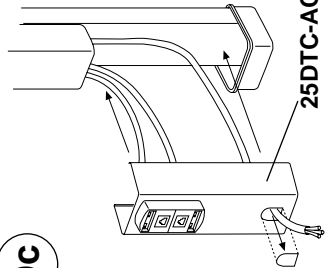

9d

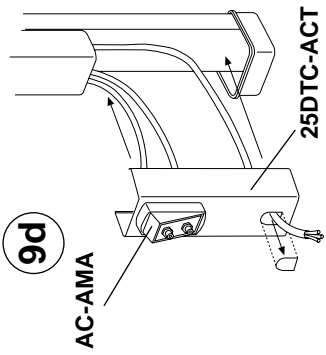

10a

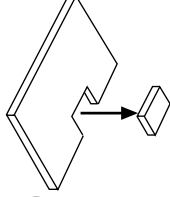

10b

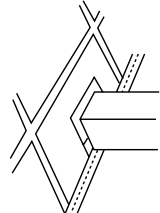

11a

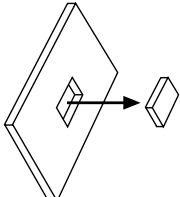

11b

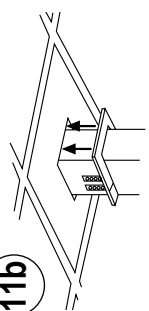

12

