

YELLOW JACKET® CLASSIC

Components and Dimensions

YELLOW JACKET® CLASSIC

Extra Heavy Duty, Extra Long Life

1 channel system

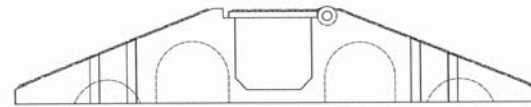

DESCRIPTION	MODEL #	Length (A)	Width (B)	Height (C)	Weight (lbs.)	Width (D)	Channel Height (E)
Cable Protector	YJ1-300	36.00"	21.00"	4.00"	40	3.00"	3.00"
Cable Protector	YJ1-500	36.00"	27.00"	6.00"	90	5.00"	5.00"

2 channel system

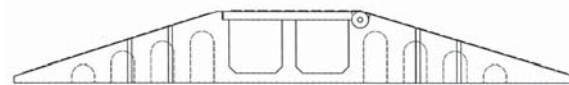

DESCRIPTION	MODEL #	Length (A)	Width (B)	Height (C)	Weight (lbs.)	Width (D)	Channel Height (E)
Cable Protector	YJ2-400	36.00"	42.00"	5.00"	130	4.00"	4.00"

3 channel system

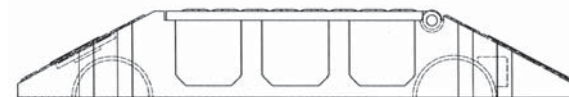

DESCRIPTION	MODEL #	Length (A)	Width (B)	Height (C)	Weight (lbs.)	Width (D)	Channel Height (E)
Cable Protector	YJ3-225	36.00"	20.00"	3.00"	32	2.25"	2.25"
End Boots (pair, M/F)	YJ3EB-225	6.00"	20.00"	3.00"	16	2.25"	2.25"
Left Turn	YJ3TL-225	25.00"	20.00"	3.00"	22	2.25"	2.25"
Right Turn	YJ3TR-225	25.00"	20.00"	3.00"	22	2.25"	2.25"
Cable Protector, Wide	YJ3-225W	36.00"	27.00"	3.00"	48	2.25"	2.25"

4 channel system



DESCRIPTION	MODEL #	Length (A)	Width (B)	Height (C)	Weight (lbs.)	Width (D)	Channel Height (E)
Cable Protector	YJ4-125	36.00"	18.00"	2.00"	26	1.25"	1.10"
End Boots (pair, M/F)	YJ4EB-125	6.00"	18.00"	2.00"	8	1.25"	1.10"
Left Turn	YJ4TL-125	25.00"	18.00"	2.00"	14	1.25"	1.10"
Right Turn	YJ4TR-125	25.00"	18.00"	2.00"	14	1.25"	1.10"
Cable Protector	YJ4-200	39.40"	22.00"	2.80"	42	2.00"	2.00"



The Durable Cable Protector for High Speed, Heavy Volume Applications.



Please refer to www.yjams.com or call our Sales Department at (626) 357-7051 for information regarding warranty limitations



MADE IN USA



Yellow Jacket® "Classic" is a single piece cable protector designed for extra heavy duty applications. It is built to withstand constant, high speed, heavy traffic from trucks, buses and other vehicles. Yellow Jacket® Classic is "The Original and The Best". It's built to outperform newcomers with 30% more polyurethane than other 5-channel cable protectors that use a dog bone connector. This additional polyurethane keeps a Yellow Jacket® in place and gives it higher load capacity, longer life and the ability to absorb abuse that would easily damage other cable protectors. Yellow Jacket's proven durability makes it the best value on the market.

ADA Compatible Ramps



The WASP®AMS® compatible special access ramps are available

Superior Handling of Heavy, High Speed Vehicular Traffic

Vehicular traffic produces the greatest impact on a cable protector's leading edges and its ramps. Yellow Jacket's superior engineering and materials have been proven in over 20 years of demanding use, making them the most durable on the market. Yellow Jacket® cable protectors are able to absorb significantly more impact from vehicles due to the design of their ramps, which includes:

Proven Durability in Over 20 Years of Use

- 20+ year old Yellow Jackets are still in the field handling trucks, forklifts and other vehicles every day.
- Made from Durathane® - a proprietary cast molded polyurethane with superior tear and abrasion resistance, and dynamic load bearing properties.
- Engineered to withstand continuous heavy, high speed vehicular traffic

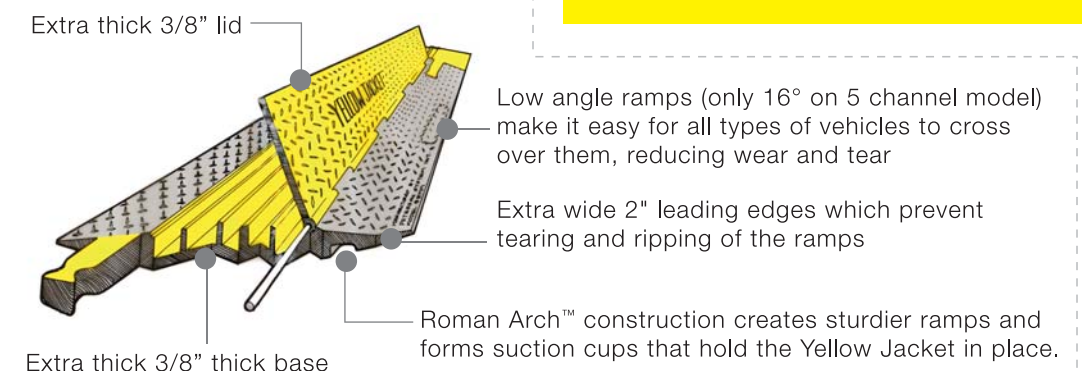

Ask for the Original • Ask for the Best™ • Ask for Yellow Jacket

Tel 626.357.7051 | Fax 626.303.3066 | Email sales@yjams.com | www.yjams.com
P.O. Box 1557, 2350 East Central Ave., Duarte, CA 91010-2984

A Division of
Peterson Systems International, Inc.

Ask for the Original • Ask for the Best™ • Ask for Yellow Jacket

YELLOW JACKET® CLASSIC

Extra Heavy Duty, Extra Long Life

YELLOW JACKET® CLASSIC

YJ5-125 Cable Protector and Accessories



MADE IN USA

Uses the Original dog bone Connector*

- Provides quick assembly and disassembly
- Resists breaking under pressure - will release before it breaks
- Most popular cable protector connector on the market

Easy to Load

- Yellow Jackets® have top hinged lids for easy access

Distinctive Highly Visible Yellow and Black

- Yellow Jacket® lids are made in high visibility yellow with contrasting black ramps

Wide Variety of Configurations

- 1-5 channel models available
- Channel sizes of 1 1/4" to 5"

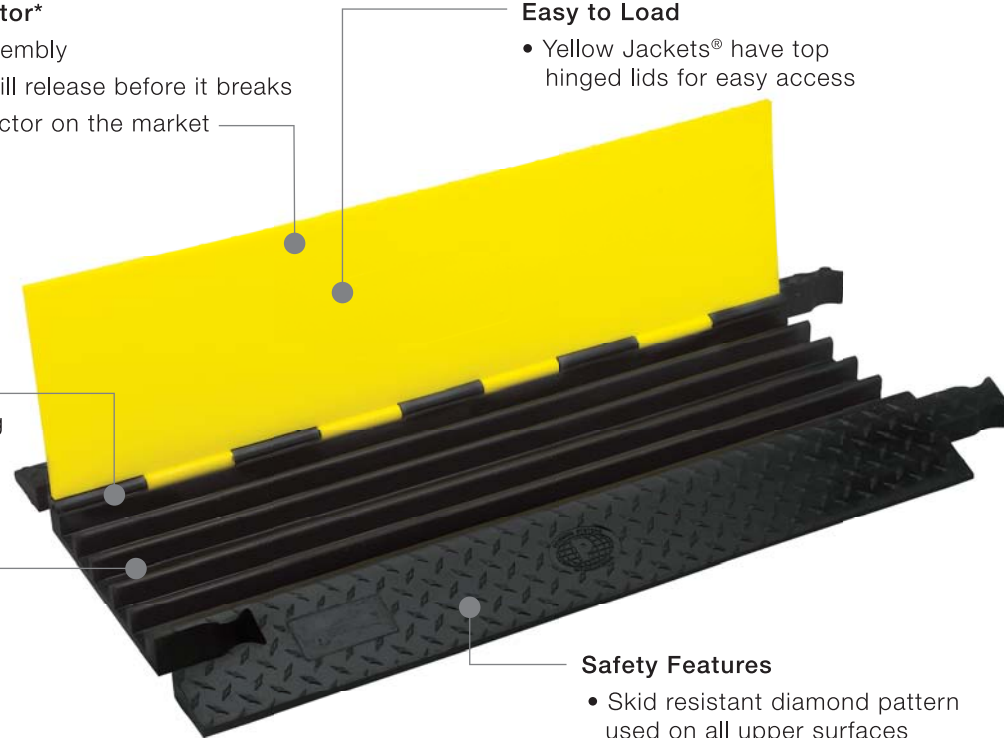

Safety Features

- Skid resistant diamond pattern used on all upper surfaces
- Non-conductive, no metal parts

Protect and Organize Cables, Lines and Hoses

Yellow Jacket® offers superior protection for electrical cables, hydraulic and pneumatic hoses and data, video and signal lines.

- Multi-channel design helps organize cables
- Rounded dividers protect cables from snags and tears

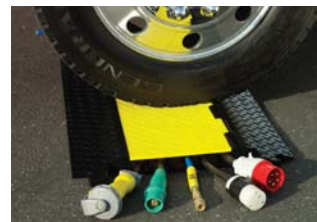

Stays in Place

While other cable protectors may shift under stress, Yellow Jackets® will stay in place because of:

- Heavy weight construction - a 5 channel Yellow Jacket® weighs 28 lbs.
- The Roman Arch™ in the ramp functions like a suction cup when a vehicle passes over a Yellow Jacket®

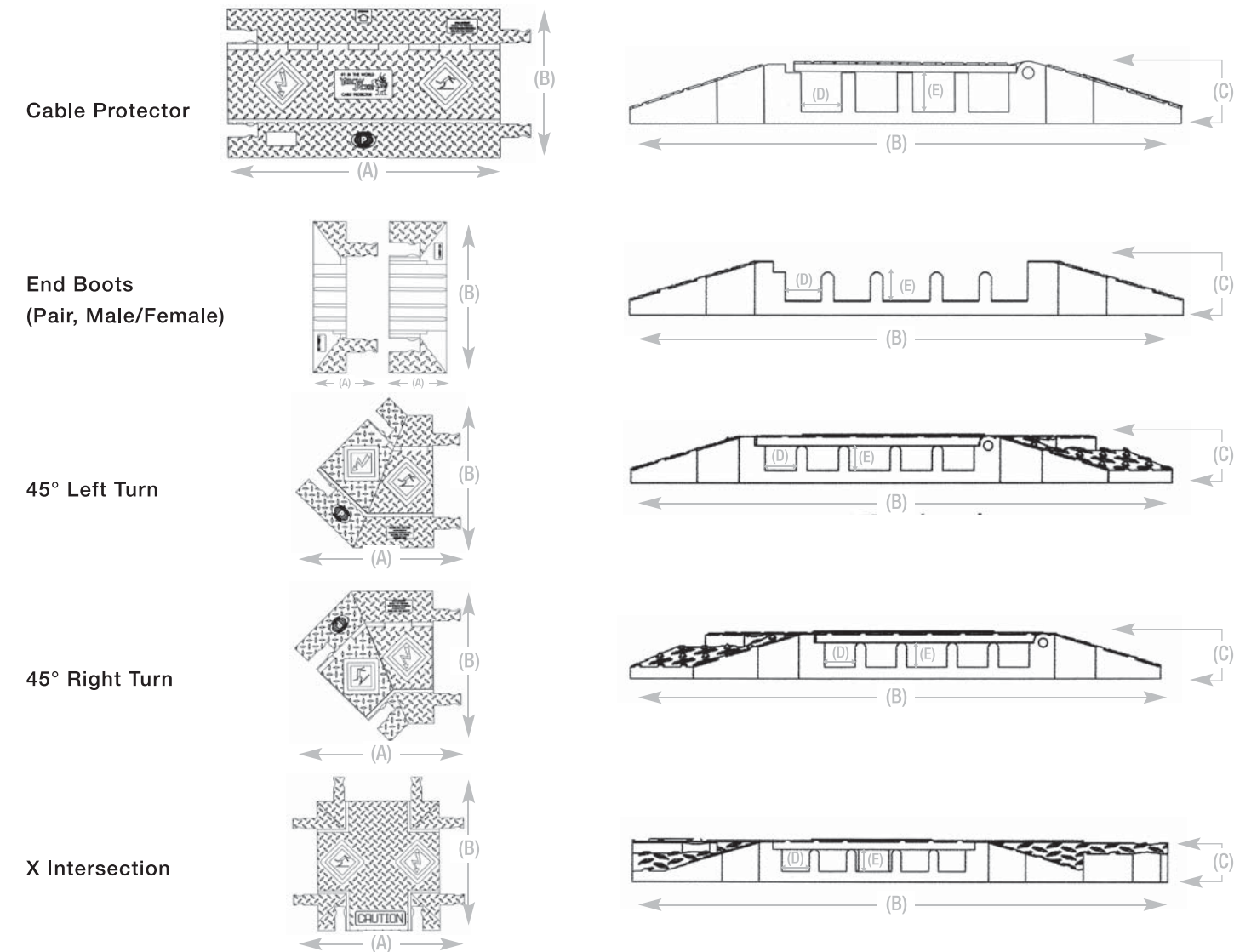

YJ5-125 cable protectors and accessories used as exemplary representations. Drawings are representational and are not necessarily to scale.

5 channel system

DESCRIPTION	MODEL #	Length (A)	Width (B)	Height (C)	Weight (lbs.)	Channel Width (D)	Channel Height (E)
Cable Protector	YJ5-125	36.00"	20.00"	2.00"	28	1.25"	1.10"
End Boots (pair, M/F)	YJ5EB-125	6.00"	20.00"	2.00"	8	1.25"	1.10"
Left Turn	YJ5TL-125	25.00"	20.00"	2.00"	15	1.25"	1.10"
Right Turn	YJ5TR-125	25.00"	20.00"	2.00"	15	1.25"	1.10"
X-Intersection	YJ5X-200	19.00"	20.00"	2.00"	16	1.25"	1.10"

* dog bone connector was designed by Yellow Jacket, Inc's parent corporation and is licensed to other manufacturers.

Ask for the Original • Ask for the Best™ • Ask for Yellow Jacket

Tel 626.357.7051 | Fax 626.303.3066 | Email sales@yjams.com | www.yjams.com
P.O. Box 1557, 2350 East Central Ave., Duarte, CA 91010-2984